

Article number: 435700015

Description: Rota-fix shaft-hub connection K 15x28

Note: Self centering. Medium torque

## Measures

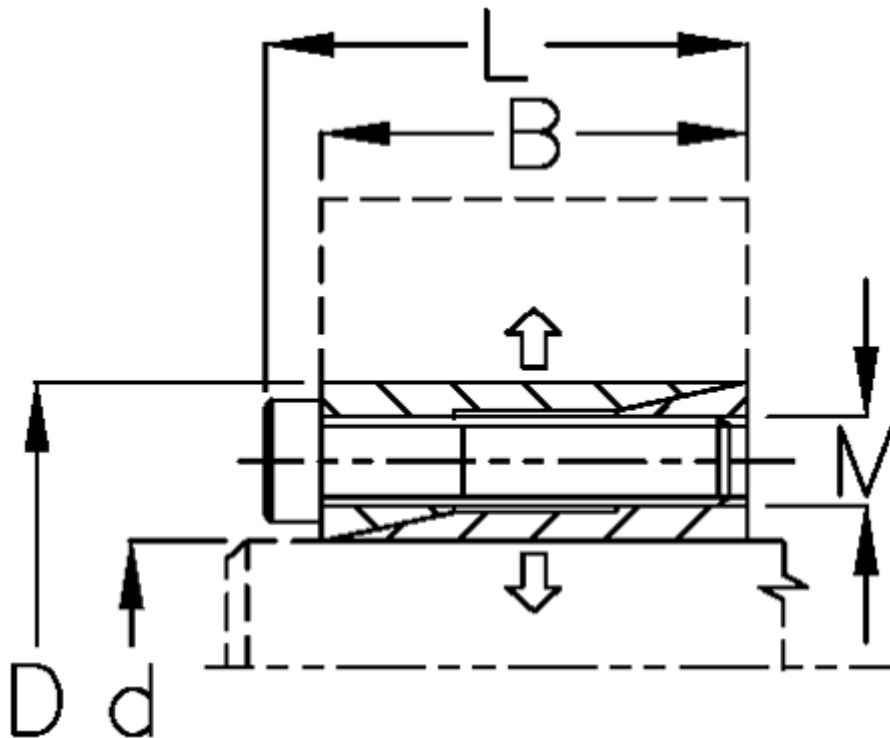

B mm	= 17
d mm	= 15.00
D mm	= 28
Fit tolerance	= Aksel h8, Nav H8
F kN torque	= 5.0
L mm	= 20.0
M mm	= M3
P N/mm <sup>2</sup> surface pressure on shaft/hub	= 50

Surface roughness	= R? ? 3.2 $\mu$ m
T N m torque	= 40
Ts N m bolt tightening torque	= 2.1